

1:400

wydrukuj na papierze 80 g/m²
(typowy papier do domowych drukarek)

print on 80 g/m² paper
(typical home printer paper)

F4F Wildcat

TBF Avenger

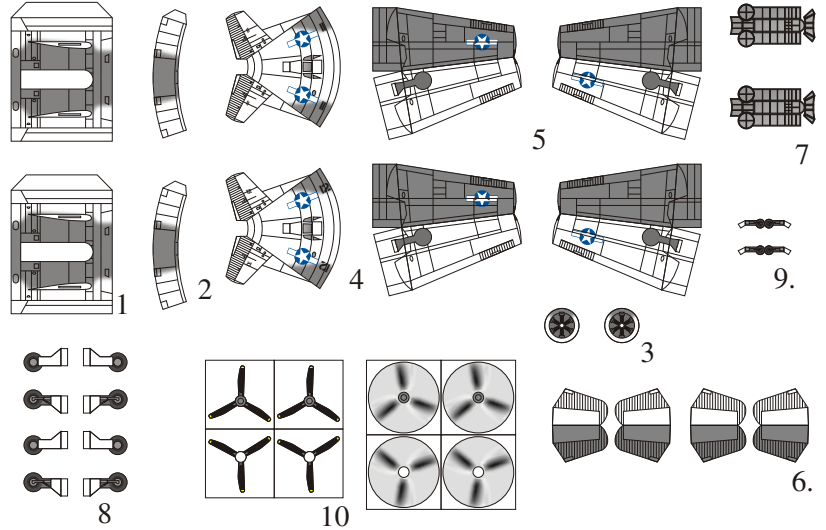
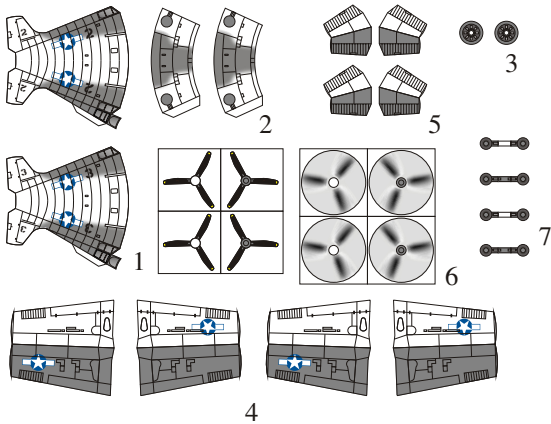

Arado 196 A-2/A-3

Westland Sea King

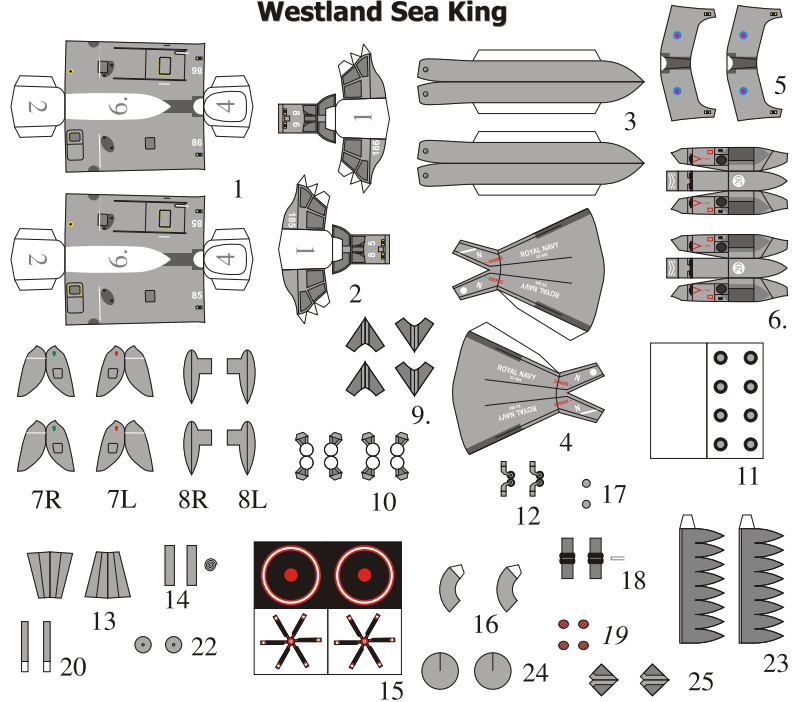
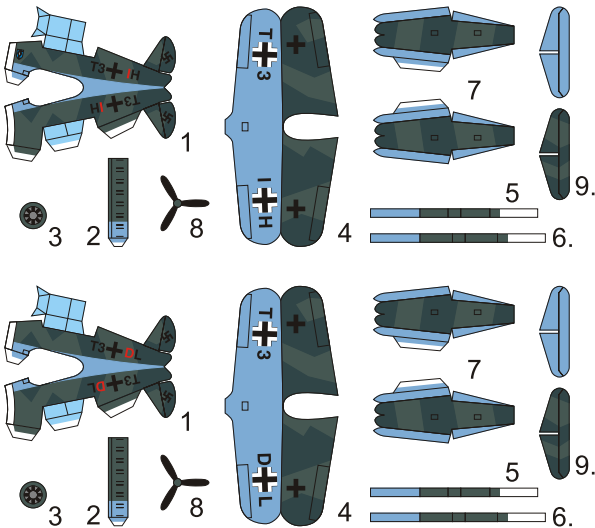

British Aerospace Sea Harrier FA2

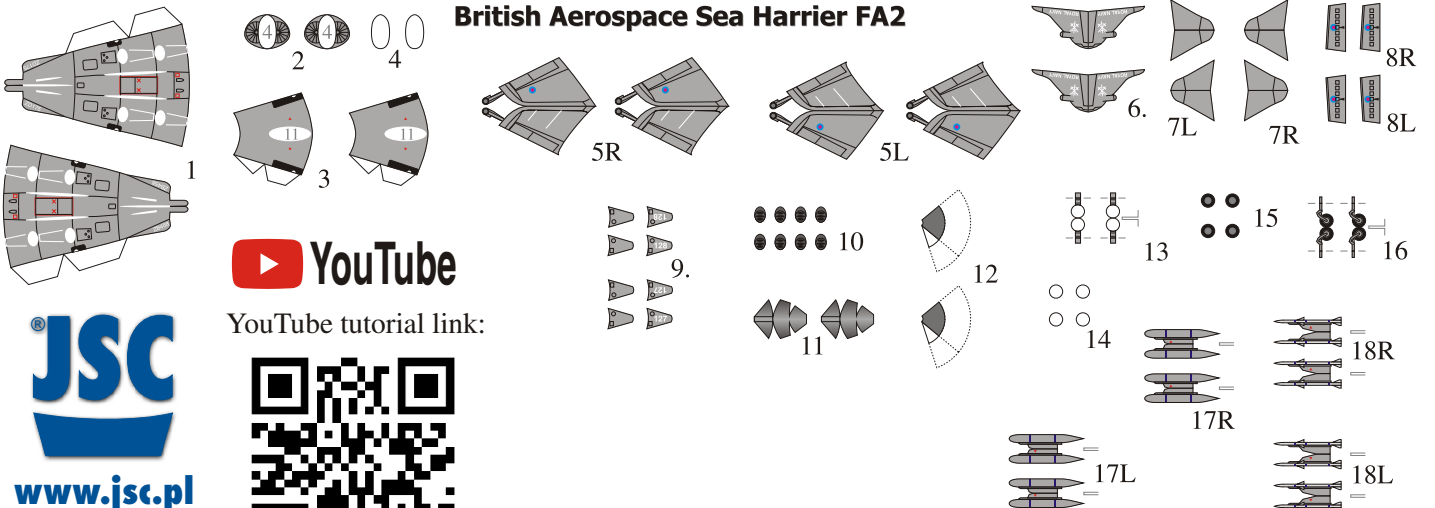

YouTube tutorial link:



1:400

wydrukuj na papierze 160-190 g/m²

print on 160-190 g/m² paper

F4F Wildcat

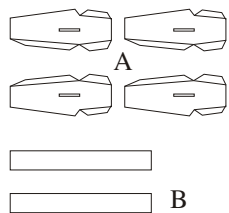

TBF Avenger

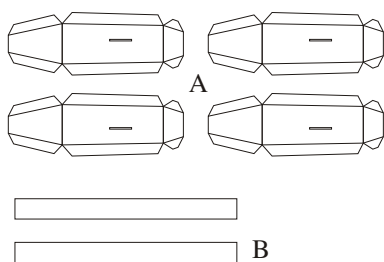

Westland Sea King

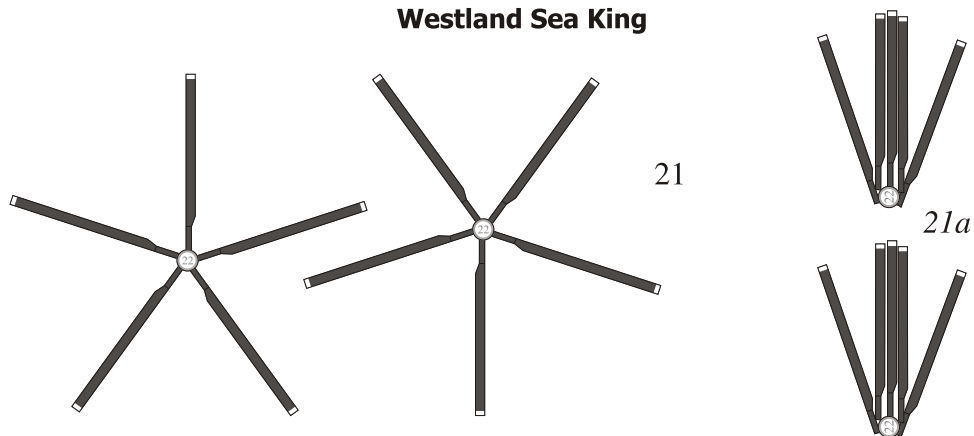

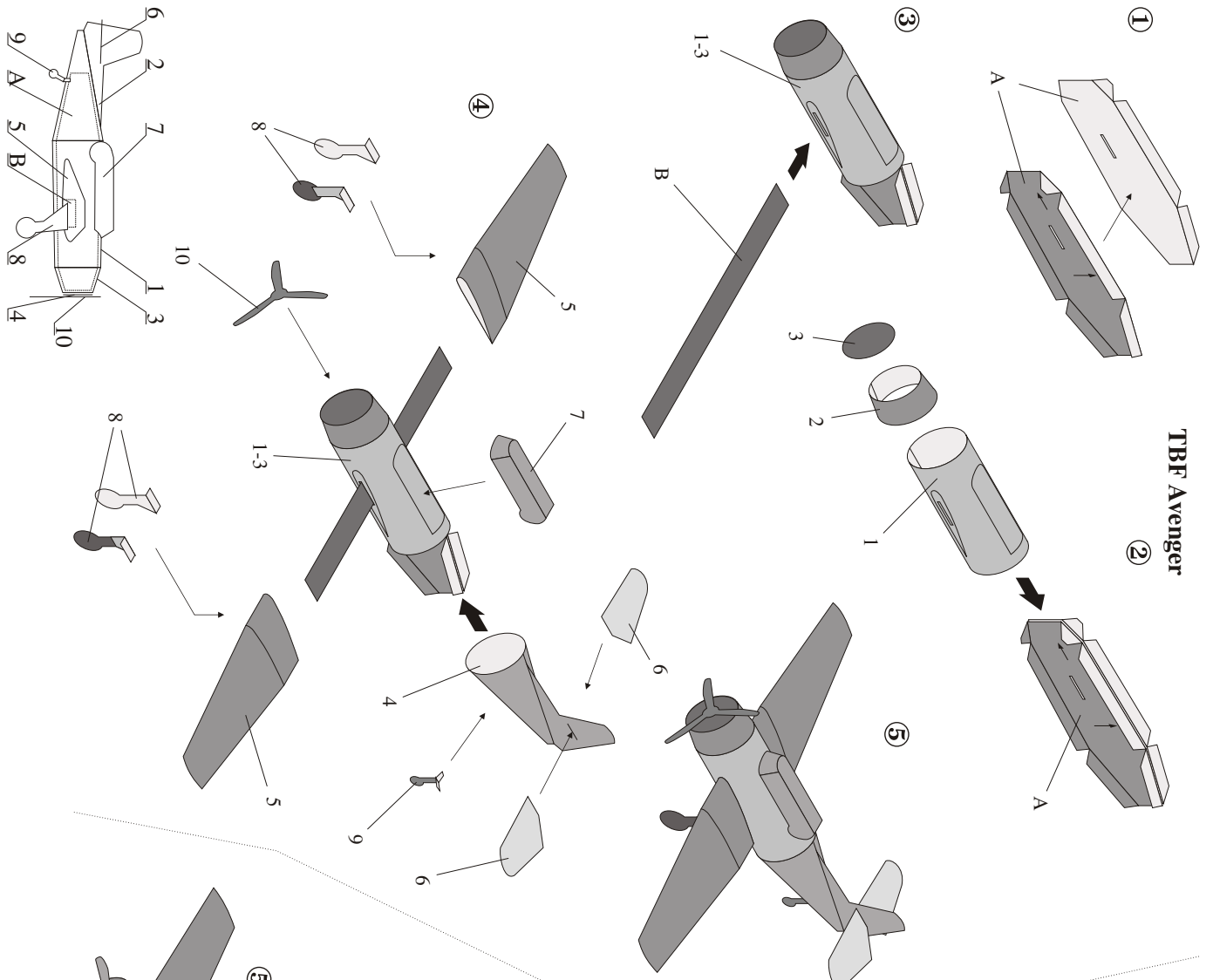

TBF Avenger

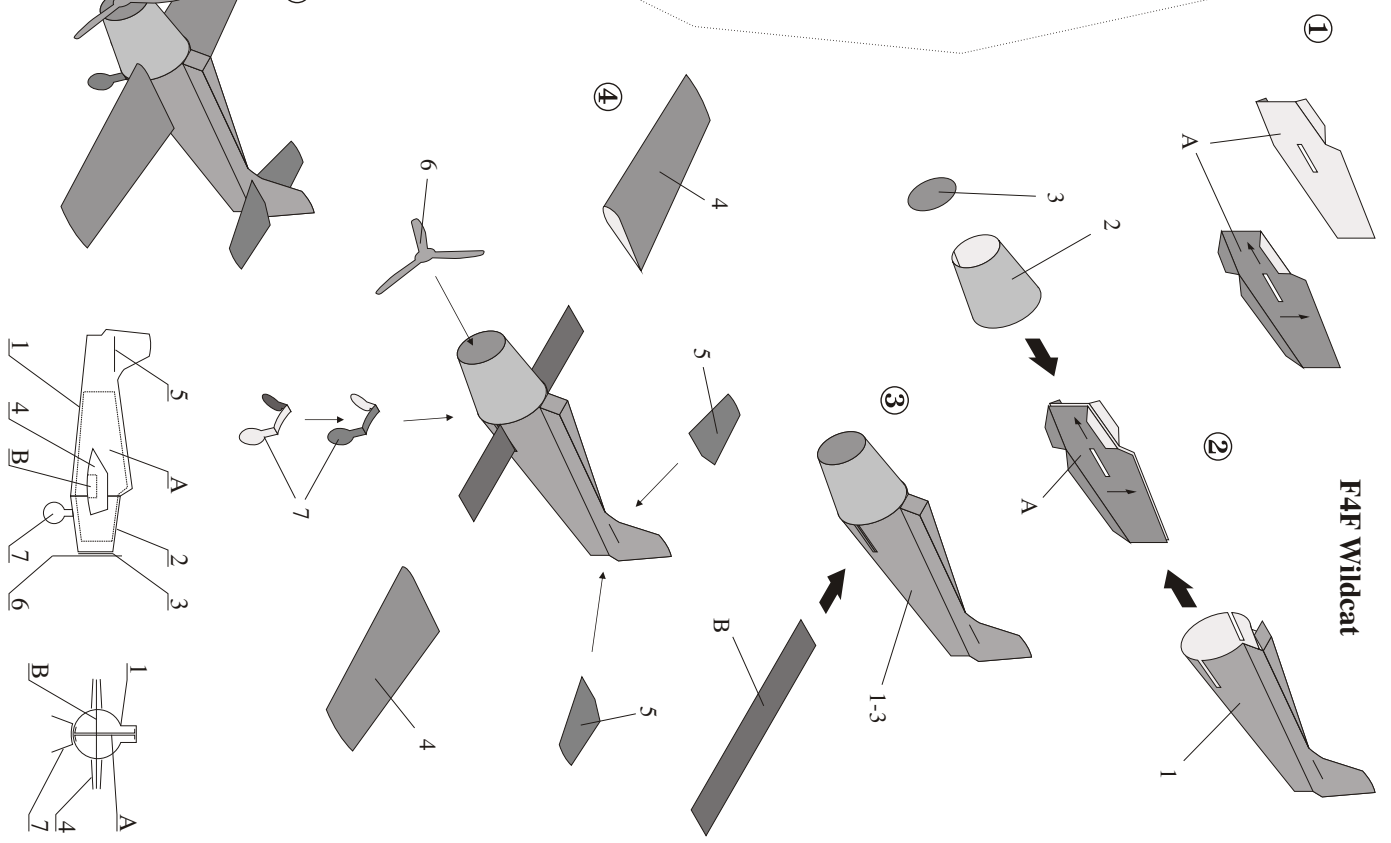

F4F Wildcat

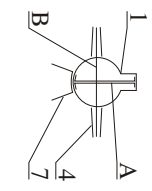
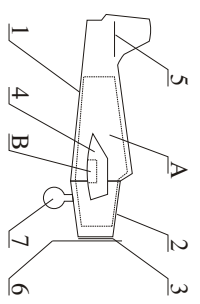
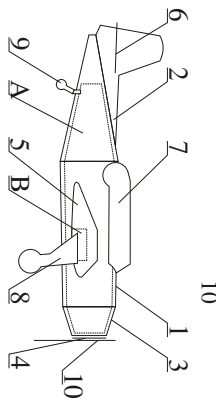

Arado 196 A-2/A-3

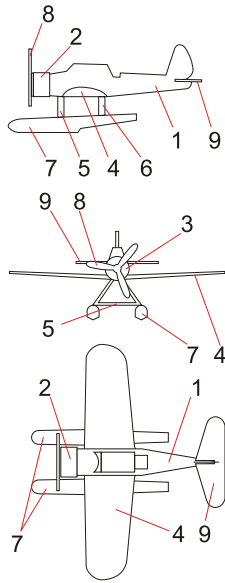

Westland Sea King

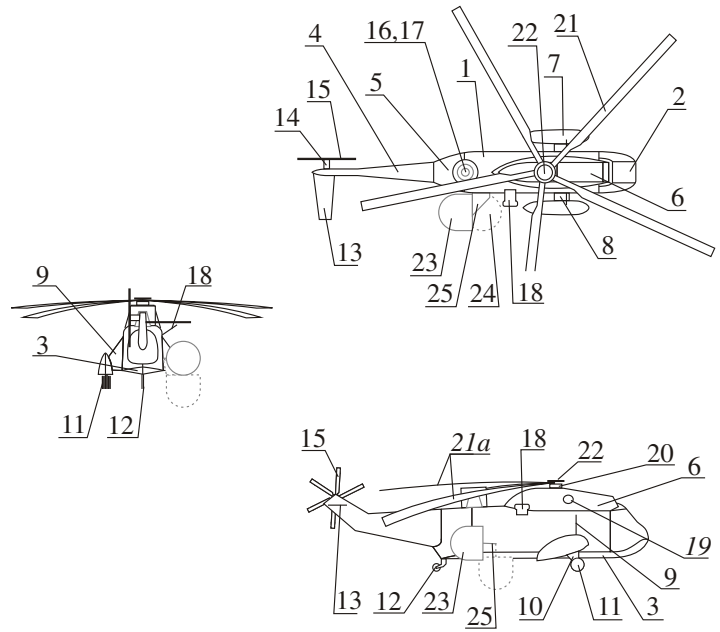

British Aerospace Sea Harrier FA2

